

Otowave 102-C

OPERATING MANUAL



ABOUT THIS MANUAL

READ THIS OPERATING MANUAL BEFORE ATTEMPTING TO USE THE INSTRUMENT.

This manual is valid for the Otowave 102-C (applies from firmware version 1.0.0.084600 onwards – see System Information screen).

This product is manufactured by:

Amplivox Ltd
3800 Parkside, Solihull Parkway,
Birmingham Business Park, Birmingham,
West Midlands,
B37 7YG
www.amplivox.com

For all inquiries contact us under:

Amplivox Ltd
10393 West 70th Street
Eden Prairie
MN 55344
United States

Tel: 888 941 4208
Fax: 952 903 4100
info@amplivox.us

Amplivox Ltd
3800 Parkside, Solihull Parkway,
Birmingham Business Park, Birmingham,
West Midlands,
B37 7YG
United Kingdom
Tel: +44 (0)1865 880846

hello@amplivox.com



DGS Diagnostics A/S
Audiometer Alle 1
5500 Middelfart, Denmark

TABLE OF CONTENT

ABOUT THIS MANUAL	1
TABLE OF CONTENT	2
1. INTRODUCTION	4
1.1. THANK YOU	4
1.2. INTENDED APPLICATIONS	4
1.3. FEATURES	4
1.4. UNPACKING	4
1.5. STANDARD CONTENTS AND OPTIONAL ACCESSORIES	5
1.6. GUARANTEE	6
1.7. WARNINGS	6
2. IMPORTANT SAFETY INSTRUCTIONS	7
2.1. PRECAUTIONS	7
2.2. ELECTROMAGNETIC COMPATIBILITY (EMC) CONSIDERATIONS	7
3. PRINCIPLES OF OPERATION	8
3.1. OTOSCOPIC EXAMINATION	8
3.2. PRINCIPALS OF ADMITTANCE MEASUREMENT	8
3.3. TYMPANOGRAM	8
3.4. ACOUSTIC REFLEX MEASUREMENT	9
4. USING THE OTOWAVE	10
4.1. BATTERY-PACK	10
4.2. OPERATING LANGUAGE	10
4.3. THE CRADLE	10
4.3.1. General	10
4.3.2. Connectors	10
4.3.3. Indicators	11
4.4. CONTROLS AND INDICATORS HANDHELD UNIT	13
4.5. THE PROBE	14
4.6. START-UP AND MENU DISPLAYS	14
4.7. INITIAL SETTINGS	15
5. TAKING MEASUREMENTS	16
5.1. PRIOR TO TESTING AND AMBIENT CONDITIONS	16
5.2. EAR TIP(S)	16
5.3. PERFORMING A TEST	16
5.4. EAR SEAL CHECK	20
5.5. ERROR MESSAGES	21
6. CONFIGURATION	22
6.1. SWEEP SETTINGS	22
6.2. REFLEX OPTIONS	22
6.3. SYSTEM SETTINGS	24
7. SAVING RESULTS IN THE INTERNAL DATABASE	25
7.1. DATA ENTRY	25
7.2. DATABASE FULL	26

8. COMMUNICATION	27
9. TRANSFERRING THE RESULTS	27
9.1. SENDING THE RESULTS TO A PRINTER	27
9.2. DATA TRANSFER TO NOAH OR AMPLISUITE	27
10. DATA MANAGEMENT	28
10.1. LIST RECORDS	28
10.2. DELETE RECORDS	29
10.3. PRINT RECORDS	29
11. PERFORMING DAILY CHECKS	30
12. SYSTEM INFORMATION	31
13. ROUTINE MAINTENANCE	32
13.1. CLEANING THE OTOWAVE	32
13.2. EAR TIP AND PROBE	32
13.3. CALIBRATION AND REPAIR OF THE INSTRUMENT	32
14. ERROR MESSAGES & FAULT CONDITIONS	33
15. TECHNICAL SPECIFICATION	35
15.1. PERFORMANCE	35
15.2. EQUIPMENT CLASSIFICATION	37
15.3. SYMBOLS	38
(I) DISPOSAL INFORMATION	39
(II) EMC GUIDANCE & MANUFACTURER'S DECLARATION	40
16. USE WITH NON-MEDICAL ELECTRICAL EQUIPMENT	44

1. INTRODUCTION

1.1. THANK YOU

Thank you for purchasing an Amplivox Otowave 102-C, a hand-held, portable tympanometer that will give many years of reliable service if treated with care.

1.2. INTENDED APPLICATIONS

The Otowave 102-C is designed for use by audiologists, general practitioners, hearing aid dispensers and child health professionals.

The instrument performs two types of measurement:

Tympanometry is used to measure the compliance of the tympanic membrane and middle ear at a fixed frequency over a range of pressures.

Reflex tests are used to measure stapedial reflexes. The Otowave measures ipsilateral reflexes and, when selected, reflex measurement is automatically carried out after a tympanogram is taken.

1.3. FEATURES

- Automatic measurement of ear canal volume, tympanic compliance peak, placement of the peak and the gradient
- Automatic detection of stapedial reflexes
- Up to 32, dual-ear patient tests can be stored in non-volatile memory
- Configurable settings for user preferences, held in non-volatile memory
- Printout of data to a printer.
- Data transfer to a computer via USB for storage viewing & printing using either the Amplivox “ampliSuite” software or the NOAH application
- English, French, Spanish, Portugese, Italian or German operating languages (user-selectable). Polish and Russian are also available on request.

1.4. UNPACKING

Please check the contents of the shipping carton against the delivery note to make sure that all items ordered have been included. If anything is missing, please contact the distributor who supplied your instrument or Amplivox if you purchased direct.

Please retain the original shipping carton and packaging to transport the tympanometer for annual calibration or repair.

1.5. STANDARD CONTENTS AND OPTIONAL ACCESSORIES

STANDARD ACCESSORIES

Otowave 102-C Tympanometer handset	8518500	Set of disposable ear-tips	8029344
Otowave 102-C Tympanometer Cradle	8518501	4 in 1 cavity assembly (0.2 ml/0.5 ml/2.0 ml/5.0 ml)	8011362
Amplivox 5V power supply	8512734	USB with software (ampliSuite and Noah impedance module) and operating manuals	8517685
USB cable to PC	8011241	Calibration certificate	8011512
Carry case	8501590		

OPTIONAL ACCESSORIES

Additional sets of ear tips		Probe tip	8002592 ¹
Sanibel MPT-II thermal printer (standard in US conf.)	8503007	Seal (in probe tip)	8002009 ¹
Thermal Printer paper for Sanibel MPT-II (standard in US conf.)	8029305	Printer cable – Otowave to Sanibel MPT-II (standard in US conf.)	8004419



Please note: If the thermal printer has been purchased it should be charged for a minimum of 15 hours before being used. Refer to the printer instructions for further details.

ACCESSORIES TO REORDER

Ear tip Otowave 3-5mm, 25 pieces	8012963	Ear tip Otowave 4-7mm, 25 pieces	8012965
Ear tip Otowave 7mm, 25 pieces	8013001	Ear tip Otowave 8mm, 25 pieces	8013003
Ear tip Otowave 9mm, 25 pieces	8012969	Ear tip Otowave 10mm, 25 pieces	8012971
Ear tip Otowave 11mm, 25 pieces	8012973	Ear tip Otowave 12mm, 25 pieces	8012975
Ear tip Otowave 13mm, 25 pieces	8012977	Ear tip Otowave 14mm, 25 pieces	8012979
Ear tip Otowave 15mm, 25 pieces	8012981	Ear tip Otowave 19mm, 25 pieces	8012983

¹ Applied part as according to IEC 60601-1

1.6. GUARANTEE

All Amplivox instruments are guaranteed against faulty materials and manufacture. The instrument will be repaired free of charge for a period of three years from the date of dispatch if returned, carriage paid, to the Amplivox service department. Return carriage is free of charge for customers in the UK and chargeable for overseas customers.



WARNING

The following exceptions apply:

- The pressure pump and transducers may go out of calibration due to rough handling or impact (dropping)
- The lifetime of probe, probe seals and ear tips is dependent upon conditions of use. These parts are only guaranteed against faulty materials or manufacture.

1.7. WARNINGS

Throughout this manual, the following meanings of warnings and cautions apply:



WARNING

The WARNING label identifies conditions or practices that may present danger to the patient and/or user.



CAUTION

The CAUTION label identifies conditions or practices that could result in damage to the equipment.

2. IMPORTANT SAFETY INSTRUCTIONS



WARNING

The Otowave 102-C instrument must be used only by practitioners qualified to perform tympanometric tests. It is intended for transient use as a screening and diagnostic tool; however no surgical or medical procedure should be undertaken solely on the basis of results obtained from the instrument.

2.1. PRECAUTIONS

READ THIS OPERATING MANUAL BEFORE ATTEMPTING TO USE THE INSTRUMENT

The tympanometer is for indoor use only and should be used only as described in this manual.

Refer to the precautions specified in Section 4.1 regarding the use of batteries.

Before the first use of the instrument each day, or if suspect or inconsistent results are apparent, the checks specified in Section 11 must be carried out. If these do not give the results specified, the instrument must not be used.

Never insert the probe into a patient's ear canal without a suitable ear tip fitted to the probe.

Use only the recommended disposable ear tips . These are for single use only - that is, each ear tip is intended to be used once only for a single ear for a single patient. Do not reuse ear tips as this will pose the risk of ear-to-ear or patient-to-patient cross-infection.

Do not immerse the unit in any fluids. See Section 13 of this manual for the proper cleaning procedure for the instrument and its accessories and the function of single-use parts.

Do not use the instrument in an oxygen-rich environment or in the presence of a flammable anaesthetic mixture or other flammable agents.

Do not drop or otherwise impact this instrument. If the instrument is dropped or damaged, return it to the manufacturer for repair and/or calibration. Do not use the instrument if any damage is suspected.

The instrument must be stored and used indoors within the specified temperature, pressure and humidity ranges, see Section 15.

As with all instruments of this nature, the measurements taken will be influenced by significant changes in altitude & pressure. The Otowave 102-C tympanometer must be re-calibrated at the intended operating elevation if it is to be used at elevations greater than 1000m above mean sea level.

Do not attempt to open, modify or service the instrument. Return the instrument to the manufacturer or distributor for all repair and servicing requirements. Opening the instrument will void the warranty.

2.2. ELECTROMAGNETIC COMPATIBILITY (EMC) CONSIDERATIONS

Medical electrical equipment needs special precautions regarding EMC and needs to be installed and put into service according to the EMC information in Section 17. This provides guidance on the electromagnetic environment in which to operate the instrument.

Portable and mobile radio-frequency (RF) communications equipment can affect medical electrical equipment. The instrument should not be used adjacent to or stacked with other equipment; if this is unavoidable the instrument should be observed to verify normal operation.

3. PRINCIPLES OF OPERATION

3.1. OTOSCOPIC EXAMINATION

A suitably-qualified health care professional should perform a thorough otoscopic examination to establish that the condition of the ear is suitable for the test options selected and that no contraindications are present. The latter would include obstruction of the external ear canal due to excessive wax and/or hairs, both of which would need to be removed. This is required to ensure that the probe tone delivered by the probe are able to reach the ear drum and are not reflected by cerumen or debris and thereby alter the test result.

3.2. PRINCIPALS OF ADMITTANCE MEASUREMENT

The Otowave 102-C measures the admittance of the tympanic membrane and middle ear by playing a continuous tone into the ear canal at 226 Hz. The level of this tone is calibrated to give 85 dB SPL (226 Hz) into a 2 ml cavity. The sound level this produces in the ear canal is measured using a microphone and the admittance calculated from the result.

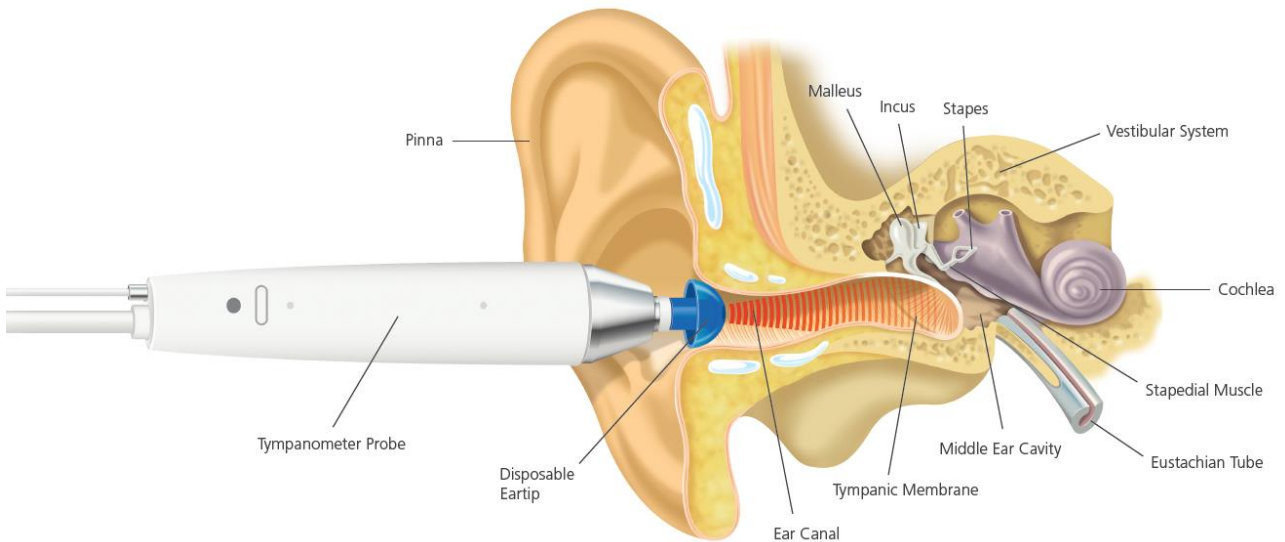

In line with normal audiometric practice admittance is displayed as an equivalent volume of air in ml (for 226 Hz). The residual ear canal volume between the probe and the tympanic membrane is always displayed in ml.

3.3. TYMPANOGRAM

Tympanometry is part of the objective impedance test and provides information about the middle ear mobility and pressure in the middle ear system.

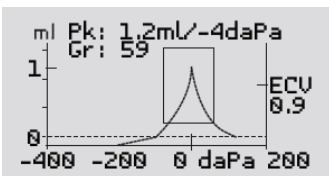

To record the tympanogram, the admittance is measured while the air pressure in the ear canal is varied from +200 daPa to -400 daPa by means of a small pump. The admittance peaks when the air pressure is the same on both sides of the tympanic membrane. The change of admittance with pressure is displayed graphically.

3.4. ACOUSTIC REFLEX MEASUREMENT

Using the same principle as in tympanometry measures, it is also possible to establish whether an acoustical reflex is present. The acoustic reflex is caused by the contraction of the stapedial muscle as a response to high-intensity stimulation of the ear. The acoustic reflex is also a natural protection of the inner ear from too high sound pressure levels which can cause damage to the hearing organ.

In acoustic reflex testing, the 226Hz tone is used to measure the admittance of the ear, while a short tone at a different frequency is presented (the reflex stimulus). The level of this stimulus is increased in steps until the stapedial muscles respond, causing the tympanic membrane to become stiffer, or a preset maximum level is reached. When the change in admittance exceeds a predetermined threshold this constitutes a reflex and the change in admittance at that level when the stimulus is applied is displayed as a plot against time.

The stapedial reflex is measured at the static ear canal pressure that produces the maximum membrane admittance, so reflex measurements are taken after the tympanogram is measured when the peak admittance pressure has been established.

The reflex stimulus is produced in the ear being measured.

4. USING THE OTOWAVE

4.1. BATTERY-PACK

The Otowave 102-C is powered by a rechargeable, built-in Nickel-Metal Hydride (NiMH) battery-pack. The battery is not intended to be changed by the user. The battery pack may explode or cause burns, if disassembled, crushed or exposed to fire or high temperatures. Do not short-circuit.

A battery state indicator  is shown in the top right corner of the display (except when showing test results). This shows the battery state as a progressively emptying battery. The 102-C should always be placed on its cradle when not in use to allow the battery to trickle charge. When the symbol “!” appears next to the battery state indicator, or when advised at switch-on the handset must be placed on its cradle to charge before further use.

Depleted batteries do not affect the instrument configuration, the contents of the database, the calibration settings or the results of the last test.

4.2. OPERATING LANGUAGE

To set the operating language (English, French, Spanish, Italian, Portuguese or German. Polish and Russian are also available on request) use the options within the CONFIGURATION menu.

4.3. THE CRADLE

4.3.1. GENERAL

The Otowave 102-C is powered by a rechargeable Nickel-Metal Hydride (NiMH) battery-pack which is fitted in the instrument. If the instrument is placed onto its cradle the battery will trickle charge.

4.3.2. CONNECTORS

The mains adapter is supplied as part of the equipment. Connect the output lead from the adapter into the power socket in the rear of the instrument cradle. Switch on the mains supply. The mains adapter is the mains disconnect device and therefore the tympanometer should be positioned such that easy access to the mains adapter is possible.





The output from mains adapter is fitted with electronic circuit protection. In case of overload the adapter will shut down. When the fault is cleared the adapter will operate as normal. However, the input to the mains adapter is

protected with a non-replaceable fuse. If this fails, the adapter will not operate. If a replacement mains adapter is required, please contact Amplivox directly, or your distributor.

The mains adapter is the mains disconnect device and therefore the audiometer should be positioned such that easy access to the mains adapter is possible.

The cradle connections are labeled to ensure correct identification and connection as follows:

Socket Label	Socket Type	Connected Part
	RJ6 socket	Supplied printer *
 5V 0.2A	2.5mm power jack	Mains AC/DC adapter *
USB	USB connector Type B	Computer (via USB port)





WARNING

For connected parts marked * , make sure to only connect the parts or accessories supplied with the instrument or supplied by Amplivox or an Amplivox distributor. These parts have been tested for use with the Otowave 102-C for compliance with the standards IEC 60601-1 and IEC 60601-1-2. The use of accessories other than those specified may compromise compliance with these standards.

4.3.3. INDICATORS

The LED indicators on the instrument cradle show the status of the mains connection and the battery charging.

Icon	Status	LED
	LED displays green when power is applied to the cradle; otherwise it will be off.	 On
	LED shows green when the handset is located in the cradle and its internal battery pack is charging; it will be off when the handset is removed.	On

4.4. CONTROLS AND INDICATORS HANDHELD UNIT

Press the On/Off key momentarily to turn the Otowave 102-C on or off (refer to the diagram below).



Please note: This instrument is equipped with a real-time clock. Before use, please set the date & time to local values in order to ensure that test data and calibration status are correctly identified.

Refer to Section 6.

No warm-up time is required, although a short diagnostic routine will run for a few seconds. During this time the internal pump will operate. To switch off, again press the On/Off key momentarily.

Press the up ▲ and down ▼ navigation keys to scroll through the menus or set values

Press the right navigation key ► to accept a menu choice or go to the next step.



Press the left navigation key ◀ to cancel an operation or go back to the previous step.

The function of the left and right keys is usually shown on the bottom line of the display.

When not performing a test the Otowave 102-C will switch off automatically after 90 or 180 seconds if no key is pressed (see Section 6 to make this selection).



The indicators show the status of the system. Typical indications during a measurement sequence are as follows:

Status	LED A	LED B
		
Otowave turned off	Off	Off
Idle, test completed or test cancelled	On	Off
Insert probe or remove probe (refer to display for details)	Flashing	Flashing

	(fast)	(fast)
Ensure probe is held steady while an ear seal is obtained	Off	Flashing (slow)
Testing - tympanogram and/or reflex measurement	Flashing (slow)	Off

For a full description of indicators used, messages displayed and possible error conditions refer to Section 14.

4.5. THE PROBE

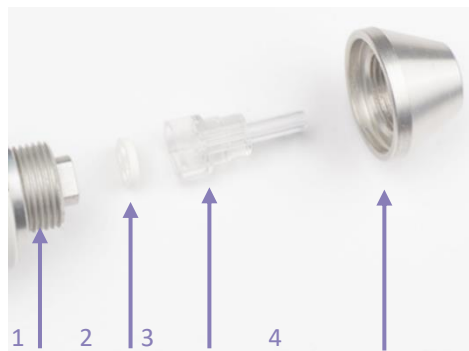

- 1 Boss and Nut** Connection on probe body for attaching nose cone
- 2 Seal gasket** Gasket used to ensure air flow
- 3 Probe tip** Transparent probe tip which houses the gasket
- 4 Nose cone** Top part of probe to securely fasten probe tip and gasket

The small holes through the Otowave probe tip must be kept clear. If these become blocked a warning message will be displayed. The probe tip must be removed and replaced.

To remove the probe tip, unscrew the nose cone and remove the probe tip from the boss. A small seal will be found in the base of the probe tip. This should be examined and replaced if it is blocked or damaged. Do not remove the nut securing the boss to the body of the instrument.



Please note: When replacing the probe tip, ensure that the seal is correctly located with the flat side aligned with the flat side within the base of the probe tip. Push the probe tip over the boss and replace the nose cone. Make sure that the nose cone is screwed home firmly but do not over-tighten. Do not use any tools to tighten the nose cone.

After replacing the tip a Daily Check should be carried out (see Section 11).

4.6. START-UP AND MENU DISPLAYS

When the Otowave 102-C is turned on the start-up screen is shown while internal tests are performed and the pump is initialised. When the start-up sequence is complete the MAIN MENU is displayed:

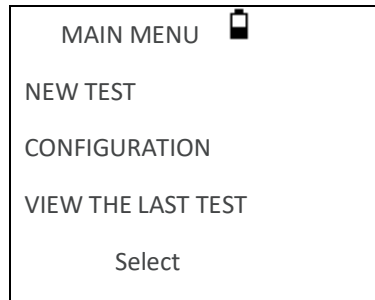

Use the navigation keys to scroll through and select menu options.

4.7. INITIAL SETTINGS

Use the CONFIGURATION options (see Section 6) to select the following options as required:

- display contrast for ease of viewing
- correct local date and time
- date format (DD/MM/YY or MM/DD/YY)
- power-off delay (90 or 180 seconds)

5. TAKING MEASUREMENTS

5.1. PRIOR TO TESTING AND AMBIENT CONDITIONS

A suitably-qualified health care professional should perform a thorough otoscopic examination to establish that the condition of the ear is suitable for the test options selected and that no contraindications are present. The latter would include obstruction of the external ear canal due to excessive wax and/or hairs, both of which would need to be removed.

Tympanometric and reflex testing should always be performed in a quiet room.

5.2. EAR TIP(S)



Amplivox YouTube video is available for assistance on how to choose the right ear tip.

These must be selected and fitted by a practitioner qualified to perform tympanometric tests.



Please note: The probe tip must be fitted with a new ear tip before it is presented to a patient's ear canal. The ear tip must be fitted completely to the probe tip and must not occlude any of the four holes in the probe tip. The ear tip size is chosen to suit the patient's ear and provide a comfortable pressure seal.

If experiencing issues, please refer to Section 2.1 regarding these single-use parts.

5.3. PERFORMING A TEST



Please note: Ensure that the appropriate settings have been made before carrying out a test. See below and the CONFIGURATION options in Section 6.

Having selected the required test settings, a typical tympanogram measurement and reflex tests are carried out as follows.

From the MAIN MENU select NEW TEST. Select the ear(s) required for test:

SELECT EAR

BOTH: R, L

LEFT

RIGHT

Back ↑↓ Select

The message “Deleting last test” will be displayed momentarily followed by a message to insert the probe into the ear to be tested:

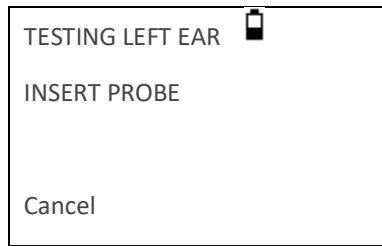

Present the ear tip to the ear and obtain a seal. If a good seal has been detected the following sequence of messages will be seen

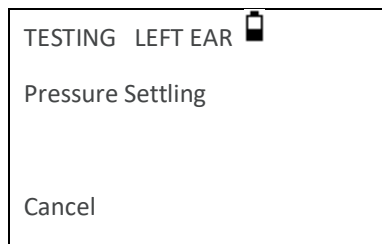
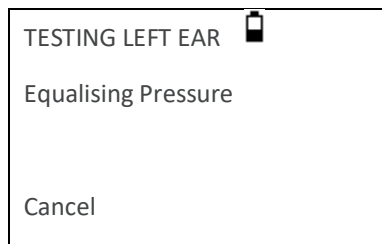

Press ◀ at any time to cancel the test and return to the ear selection menu.

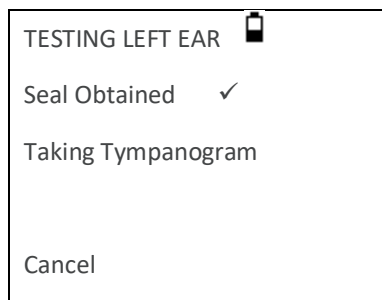

Once an adequate seal is detected the tympanogram measurement is made. This takes about 3 seconds. It is important not to move the probe and to ask the patient to remain very still during the test.

When the tympanogram is complete the instrument will perform the reflex test(s), if selected. By default this test is only performed if a peak is found in the tympanogram. This and other reflex test options may be changed in the CONFIGURATION menu, see Section 6.

Before starting the reflex test the ear canal pressure will be set to the value that gave the peak compliance during the tympanogram test. The instrument will then step through the tone frequencies and levels set in the CONFIGURATION menu searching for a reflex response.

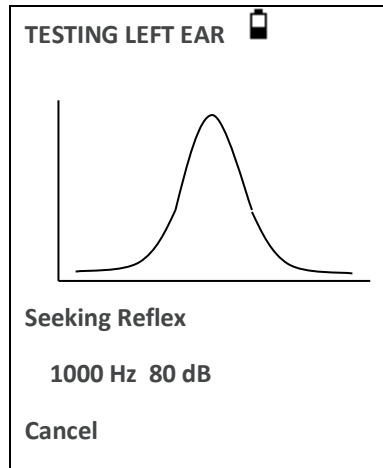

The display changes to show the frequency and level being used, starting with the lowest frequency and level selected.

When the measurement is complete the indicator on the instrument changes from flashing green to steady green. The display confirms that the test has been completed along with the instruction WITHDRAW PROBE.

Remove the probe from the patient and after a short period the tympanogram will be displayed.

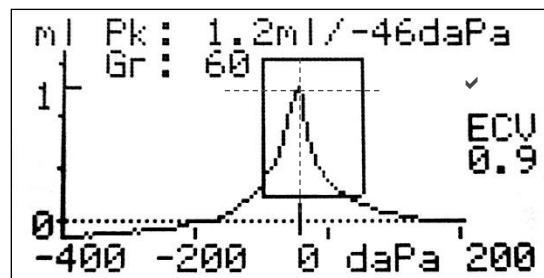

The display shows:

- The peak compliance, in ml (Pk)
- The pressure which gave the peak compliance in daPa
- The Gradient, in daPa (Gr)
- The Ear Canal Volume (ECV) in ml measured at 200 daPa.
- A pass/refer sign indicating if tympanogram appears to be normal or not
- A plot of compliance against pressure.
- Normative box (based on BSA recommendations)
- Pass (a) / Refer (x) sign when tymp peak falls into normative box or not (refer)
- Pressure cursor to be operated with up ▲ and down ▼ navigation keys.

Review the tympanogram to ensure that the peak compliance point selected by the Otowave is suitable. If required it is possible to select an alternative peak using the ▲ and ▼ keys. The figures displayed will change to reflect the peak selected, and will be saved with the tympanogram.

To repeat the test, press ◀.

When satisfied with the tympanogram press ▶.

If reflex test(s) were carried out these results will now be displayed:

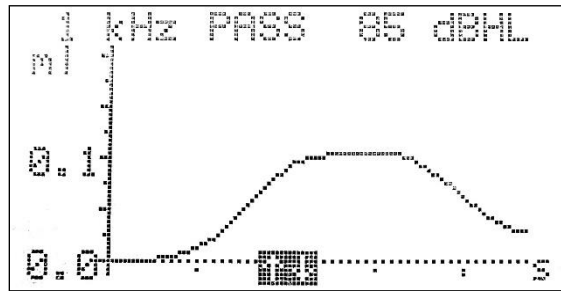

The display shows:

- The frequency and level of the reflex stimulus
- “PASS” if a reflex was found, else “x” (No Response)
- A plot of compliance against time

If the reflex test was performed at more than one frequency use the ▲ and ▼ keys to view the results for the other frequencies.

If the Otowave 102-C was set to test for a reflex at all levels of the stimulus press ► to view an additional display following the reflex graphs. This shows a summary of the levels and frequencies at which a reflex was detected. The dash symbol “-” is shown if a reflex tone was not presented at the level indicated.

REFLEX SUMMARY				
dB				
100	✓	✓	x	-
90	✓	x	✓	✓
80	x	✓	✓	✓
70	x	✓	x	x
	Hz 500	1k	2k	4k

Press ◀ to return and view the tympanogram, reflex results or to repeat the test. When satisfied with the results press ►.

The message “Saving as last test” will be displayed and the results will be saved in the “last test” memory. The results will remain available until a new test is started, even if the Otowave is turned off.

If both ears were chosen for test the entire sequence will now be repeated for the right ear:

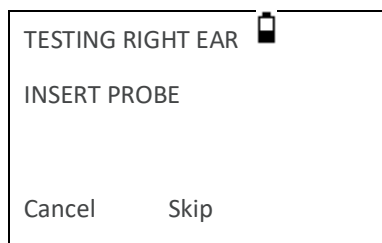

Press ► to skip testing of the right ear and display the PROCESS RESULTS menu. Press ◀ to cancel and return to the ear selection menu. In both cases the left ear results are retained and may be viewed as the LAST TEST.

Otherwise insert the probe; the right ear test will then proceed as described above.

When the selected ears have been tested and the results saved the PROCESS RESULTS menu will be displayed. This accesses the following functions:

- Print the results
- Save the results in the internal database
- Review the results as described above
- Return to the main menu

The results of the last test performed remain available even if the Otowave has been turned off. To view these results select VIEW THE LAST TEST from the main menu. After selecting the required ear the tympanogram will be displayed. It will then be possible to view the results and select the PROCESS RESULTS menu as if the test had just been completed.



Please note: Results of the last test will be erased as soon as a new test is started. Test results should be saved to the Otowave's database, printed or sent to a computer to ensure that data is not lost.

5.4. EAR SEAL CHECK

The type of ear seal check employed at the start of a test can be set in the CONFIGURATION menu (Section 6). The default STANDARD option is adequate for most tests, although it may not always be possible to generate the extremes of pressure with this setting.

However, if difficulty is experienced in using the ear tips to create a seal the alternative EXTENDED option may be helpful. This checks that a range of pressures will be available before starting a test by means of a visual indication of the quality of the seal:

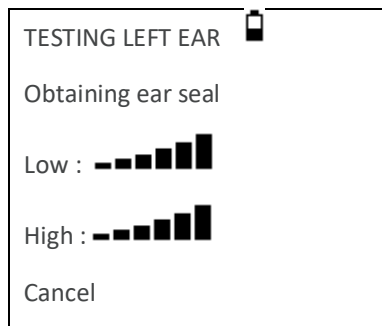

The number of bars shown indicates the robustness of the seal. The probe should be adjusted in the ear until two or more bars are shown for Low & High.

5.5. ERROR MESSAGES

The following error messages may be seen during the test sequence.

MESSAGE DISPLAYED	INDICATOR STATUS	LIKELY CAUSE(S)
WITHDRAW PROBE	Yellow Flashing	The probe has been moved during measurement. Re-insert the probe to repeat the test.
Volume outside range WITHDRAW PROBE	Yellow Flashing	The ear canal volume is above the 5ml. This message can also occur when the probe is not properly inserted into the ear.
Blocked ear WITHDRAW PROBE	Green Flashing	The ear canal volume is below 0.1ml. Check that the probe is not blocked and correctly inserted into the ear.
INSERT PROBE	Yellow Flashing	The seal was lost. Reinsert the probe to repeat the test.

6. CONFIGURATION

6.1. SWEEP SETTINGS

ITEM	DESCRIPTION	DEFAULT
Test Sequence:	When testing both ears, define what ear the test will start with.	R, L
Ear Seal Check:	<p>The STANDARD option is adequate for most tests, although it may not always be possible to generate the extremes of pressure during a tympanogram measurement with this setting.</p> <p>If difficulty is experienced in using the ear tips to create a seal the alternative EXTENDED option may be helpful. This function checks that a range of pressures will be available before starting a test by means of a visual indication of the quality of the seal.</p> <p>The EXTENDED function is especially helpful for small ear canal volumes which should not experience excessive pressure.</p>	Standard
Reload Defaults:	Reset the sweep settings to its original settings.	

6.2. REFLEX OPTIONS



Amplivox YouTube Video available on how to add ipsilateral reflexes to test protocol.

ITEM	DESCRIPTION	DEFAULT
Level Mode:	 <p>Please note: Depending on the LEVEL MODE selection, the LEVELS screen will contain different content.</p> <p>ONE LEVEL: Choose the level of reflex stimulus to apply. Only one level will be tested in the measurement. The maximum level of ipsilateral stimulus may be set to maximum 100dBHL</p> <p>MULTILEVEL: choose the maximum level of reflex stimulus to apply and the step size between the levels of the preceding stimulus. The maximum level of ipsilateral stimulus may be set between 85dBHL and 100dBHL.</p>	Multilevel
Levels:	Use the ▲ and ▼ keys to choose the maximum level of reflex stimulus to apply and the step size between the levels of the preceding stimulus. The maximum level of stimulus may be set between 85dBHL & 100dBHL. Press the ► key to confirm the selection or the ◀ key to cancel.	95 dB 5 dB steps
Frequencies:	Use the ▼ key to scroll through the frequencies available for each of the ipsilateral stimuli (500Hz, 1000Hz, 2000Hz & 4000Hz), and then the ▲ key	1kHz

	to select (✓) or deselect (-) the frequencies at which the reflex stimulus is to be applied. Then press ► to save the entire selection.	
Selection:	Use the ▲ and ▼ keys to choose the circumstances when a reflex measurement is to be made (always, never, only if a compliance peak is found, or only after confirmation is made at the start of the test sequence). In cases where a compliance peak has not been established a pressure of 0daPa is used. Press the ► key to confirm the selection or the ◀ key to cancel.	Only if peak found
Threshold:	Use the keys to choose the change in compliance required to signify that a reflex response has been detected (0.01ml to 0.5ml). The default is 0.03ml.	0.03 ml
Auto-Stop:	By default the reflex test at each frequency will stop at the lowest level of stimulus that produces a response. By setting REFLEX AUTO-STOP to NO the Otowave 102-C will test for a reflex at all selected levels. (Note that 100dBHL at 4000Hz is not available).	No
Polarity:	Define the polarity of the reflex graphs, if the reflex is plotted upwards (UP) or downwards (DOWN).	Up
Filter:	Use the keys to choose either 2Hz or 1.5Hz. The default of 2Hz is suitable for most circumstances. However if a smoother reflex plot is required for better interpretation 1.5Hz may be selected.	2 Hz
Reload Defaults:	Reset the sweep settings to its original settings.	

6.3. SYSTEM SETTINGS

ITEM	DESCRIPTION	DEFAULT
Set Time/Date:	Set the internal clock date and time. Use the ◀ and ▶ keys to select a field and the ▲ and ▼ keys to adjust the value.	
Power-Off Delay	Adjust the time when device shuts off to save power.	90 s
LCD Contrast:	Adjust the display contrast using the ▲ and ▼ keys.	
Report Cal. Dates:	Select PRINT CAL. DATES to show the calibration date on the print-out provided by the Sanibel Thermal printer.	PRINT CAL. DATES
Set Date Format:	Set the format of how the date is displayed: DD/MM/YY or MM/DD/YY	DD/MM/YY
Hospital Name:	Allows the hospital name to be entered. The name will appear at the top of the print-out.	
Department:	Allows the department name to be entered. The name will appear at the top of the print-out.	
Defaults:	Reset the system settings to the original settings.	
Language:	Change the operation language to English, German, French, Spanish, Portuguese or Italian. Polish and Russian are also available on request.	English

7. SAVING RESULTS IN THE INTERNAL DATABASE

Up to 32 tests can be saved in the Otowave 102-C internal database.

To save the results of a test select SAVE RESULTS from the PROCESS RESULTS menu that is displayed on completion of a test. This option can also be accessed by selecting VIEW THE LAST TEST from the main menu and scrolling through the results using the ► key as long as the test results have not already been saved or deleted (e.g. by starting and then aborting a new test).

A three character identifier is used for the record. This is also used as the reference for the patient's name on the printed record and for data transferred to a computer. The identifier would typically be the patient's initials, and, as the tympanometer uses a combination of this identifier and the date/time of a test to refer to stored records, this same identifier may be used for different tests for the same patient.

7.1. DATA ENTRY

PATIENT INITIALS 

ABCDEFGHIJKLM

NOPQRSTUVWXYZ

-01233456789

Hold to enter / cancel

To enter the identifier:

- Use the ▲, ▼, ◀ and ▶ keys to select a character.
- Press and hold the ▶ key to enter the selected character.
- Press and hold the ◀ key to delete the last character.

To save the test results:

- Enter all three characters for the identifier.
- Press and hold the ▶ key to save the record.

To cancel saving the last test:

- Delete any characters that have been entered.
- Press and hold the ◀ key.

7.2. DATABASE FULL

A warning will be displayed if the database is full when attempting to save a test:



Selecting MANAGE DATA will display the DATA MANAGEMENT menu which provides options for printing or transferring data to a computer prior to deleting records to make space for the new test.

DELETE OLDEST will overwrite the oldest record in memory with the results being stored.

Cancel will return to the previous menu leaving the current test temporarily stored as the last test.

8. COMMUNICATION

The Otowave 102-C can send test results to a dedicated thermal printer or a suitably-equipped computer via a USB link. When printing directly to the printer, the data is received through a cable connected between the cradle and the printer. When using a computer, the data is received through a USB cable connected between the cradle and the computer.

9. TRANSFERRING THE RESULTS

9.1. SENDING THE RESULTS TO A PRINTER



Amplivox YouTube Video available on how to send results to a printer.

The designated Sanibel MPT-II thermal printer is available as an option and only this printer should be used. The printer supplied with the Otowave 102-C is correctly configured for communication.

The Sanibel printer has no user-selectable configuration options.

Before attempting to print ensure the printer is fully charged, switched on, loaded with paper and ready to print. Also ensure the handset is on its cradle.

To print the results of the last test select SEND TO PRINTER from the PROCESS RESULTS menu. (Similar facilities for printing are available from the VIEW THE LAST TEST and DATA MANAGEMENT options in the MAIN MENU).

Press ◀ to cancel printing.

The three character identifier for the record is printed in the "Name" field followed by the Otowave graphical displays, the analysis and the results. The name of the hospital, the department, and the calibration dates for the instrument may also be printed if required. There is space for additional details to be handwritten by the clinician (patient name/age, operator & comments).

Thermal paper printouts can fade with exposure to light or heat. Consider transferring the data to a computer for permanent storage.

9.2. DATA TRANSFER TO NOAH OR AMPLISUITE

To transfer test results stored within the tympanometer to a NOAH database the Amplivox NOAH Impedance module must be installed on to a computer. Alternatively, Amplivox ampliSuite allows data to be transferred to a computer and subsequently viewed, annotated & printed. This software is supplied on a USB stick which includes this operating manual.

Refer to the installation & operating instructions provided with the NOAH Impedance Module or ampliSuite for further details. In order to use the NOAH Impedance Module the NOAH software must also be installed on the computer.

If any other messages are displayed while sending data, turn the Otowave off and then on again and try re-sending the data. If the problem persists contact an Amplivox service centre.

10. DATA MANAGEMENT

Records stored in the database of the Otowave 102-C can be listed, viewed, deleted, printed or sent to a computer using the DATA MANAGEMENT option of the main menu:

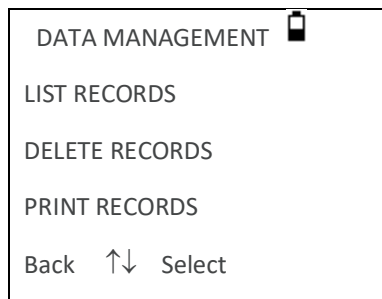

Scroll down to see the remaining choice:

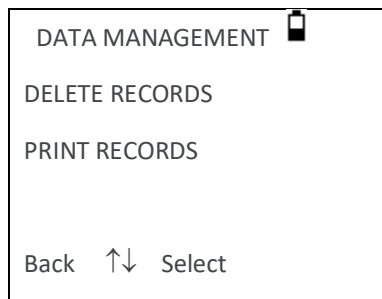



If it is required to work with the record of an individual test, select LIST RECORDS. All other options operate on groups of records.

10.1. LIST RECORDS

LIST RECORDS shows the stored tests, 6 at a time, most recent first:



Each entry shows:

- Three-letter patient identifier entered when the test was stored;
- Date and time of the test
- Whether the test has been printed ()
- Whether the test has been sent to a computer ()

- Whether the test is for the Left (L), Right (R) or both (2) ears

Press ▲ or ▼ to scroll through the records

Press ► to select the highlighted record

Press ◀ to return to the previous menu

When a record is selected the PROCESS RECORD menu will be displayed. This accesses the following functions:

- View the selected record
- Print the selected record
- Send the selected record to a computer
- Delete the selected record

10.2. DELETE RECORDS

DELETE RECORDS allows a group of records to be deleted. It is possible to delete all records, all records that have been printed or all records that have been sent to a computer.

Confirmation of the deletion is required.

10.3. PRINT RECORDS

PRINT RECORDS allows a group of records to be sent to the printer. It is possible to print all stored records or just those records that have not already been printed. If printing the entire database it is recommended that a full roll of paper is loaded into the printer.

11. PERFORMING DAILY CHECKS

The operation of the Otowave 102-C should be checked daily using the 4 in 1 test cavity supplied with the instrument.

Select the DAILY CHECK option in the main menu:

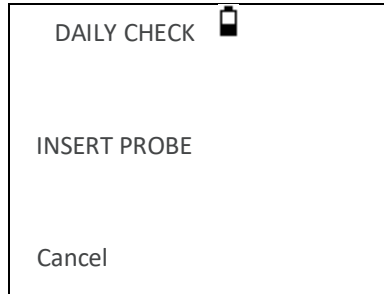

Wait until "Open" is displayed.

Insert the probe, without an ear tip, into the hole at the 2ml end of the test cavity. Make sure that the probe is pushed in fully and is held tight against the stop. The probe must be square to the end of the test cavity.

The display should show the volume of the test cavity to within ± 0.1 ml.

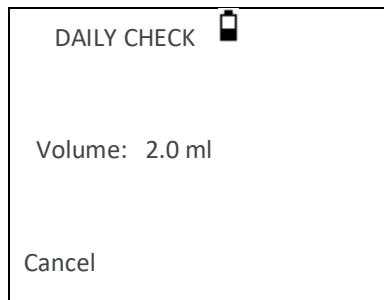

Remove the probe and repeat the test with the three remaining test cavities. The display should show the volume of the 0.2ml and 0.5ml test cavities to within ± 0.1 ml. The 5.0ml test cavity should be within ± 0.25 ml.

When the checks have been completed press ◀ to return to main menu.

12. SYSTEM INFORMATION

1	Battery:	Remaining battery capacity
2	Last Cal:	Last calibration date
3	Next Cal:	Next calibration date
4	Serial No:	Serial number of Otowave
5	Ver.:	Firmware version
6	Date and Time:	User defined date and time

13. ROUTINE MAINTENANCE

13.1. CLEANING THE OTOWAVE

The Otowave is a precision instrument. Handle it carefully in order to ensure its continued accuracy and service. Before cleaning switch off the instrument. Use a soft damp cloth and mild detergent to clean the instrument panel and case. Ensure no moisture enters the instrument.

13.2. EAR TIP AND PROBE

Ear tips should be replaced after a single use.

The probe tip and its associated seal are disposable devices.

The probe tip should be checked before each ear insertion to ensure it is undamaged and that none of the tubes through it are blocked. It should be replaced if necessary.

The seal should be replaced when the probe tip is replaced, if it shows signs of wear, or if a pressure leak is suspected.



WARNING

Handle the probe and accessories with care. Do not allow moisture, condensation, fluids or debris to enter the probe.

13.3. CALIBRATION AND REPAIR OF THE INSTRUMENT

Amplivox recommends that the Otowave 102-C is calibrated annually. Please contact Amplivox for details.

If the instrument is to be used at elevations above that specified re-calibration must be undertaken at the intended operating elevation.



WARNING

The instrument should be returned to the manufacturer for service & repair. There are no user-serviceable parts within it.

Please use the original shipping carton and packaging to transport the instrument. Place the instrument in a plastic bag before packing to prevent dirt and dust getting into the probe.

14. ERROR MESSAGES & FAULT CONDITIONS

If a fault condition cannot be cleared, the operator is cautioned against repeatedly starting the instrument.



Please note: Refer to the installation & operating instructions provided with the NOAH Impedance Module or ampliSuite software for details of the data transfer operation and errors that may occur.

PROBLEM	CAUSE	SOLUTION(S)
No pressure can be built up and the test sequence will stay in the EQUALIZE PRESSURE SCREEN .	<ul style="list-style-type: none"> No seal can be obtained Estimated volume is too high (perforated ear drum) Wrong ear tip size chosen Probe is blocked 	<ul style="list-style-type: none"> Examine the probe tip for contamination and replace the probe tip Reposition the probe Change the ear tip
No reflex test is conducted after the tympanometry even though the reflex test is active in the REFLEX SEQUENCE .	In REFLEX SELECTION the setting is set to ONLY IF PEAK IS FOUND or NEVER MEASURE .	Change settings in REFLEX SELECTION to desired option.
Last measured data cannot be found under VIEW THE LAST TEST .	NEW TEST might have been selected in between and thereby deleted the last test(s) from the short-term memory.	Data you wish to be stored should be stored immediately.
BLOCKED PROBE Indicator LED b and c flash fast.	<ul style="list-style-type: none"> Probe is blocked Probe placed against ear canal skin 	<ul style="list-style-type: none"> Examine the probe tip for contamination and replace the probe tip Reposition the probe Change the ear tip
WITHDRAW PROBE Indicator LED b and c flash fast.	<ul style="list-style-type: none"> The probe has been moved during measurement. Test has been started with the probe already inserted into the ear. 	Reposition the probe
Volume outside range WITHDRAW PROBE Indicator LED b and c flash fast.	<ul style="list-style-type: none"> Ear canal volume is > 5ml. Probe is not properly inserted into the ear. 	Reposition the probe
Pressure lost WITHDRAW PROBE Indicator LED b and c flash fast.	Ear seal has been broken while testing for seal.	Reposition the probe
Measurement timed out Indicator LED b and c flash fast.	<ul style="list-style-type: none"> Occurs when the ear seal check is set to EXTENDED Pump failed to achieve the starting pressure within 4 s. Pressure failed to reach -400 daPa within 12 s. 	Reposition the probe. Retry the test. If the problem persists, contact your Amplivox service centre.

PROBLEM	CAUSE	SOLUTION(S)
VOLUME OUTSIDE RANGE Indicator LED b and c flash.	<ul style="list-style-type: none"> Probe not placed correctly in ear canal. 	<ul style="list-style-type: none"> Reposition probe.
PROBE NOT CLEAR Indicator LED c steady light.	<ul style="list-style-type: none"> Probe is blockedProbe placed incorrectly 	<ul style="list-style-type: none"> Check that the probe is not inserted into a test cavity at start-up. Please ensure the probe is not blocked or obstructed.
AIRFLOW ERROR Indicator LED c steady light.	<ul style="list-style-type: none"> Fault with air system and/or pump. Cannot determine pump direction. 	<ul style="list-style-type: none"> Unknown pump fault. Restart the unit. If problem persists, contact your Amplivox service centre.
AIRFLOW ERROR RESTART THE UNIT Indicator LED c steady light.	Fault with air system and/or pump.	<ul style="list-style-type: none"> Restart the unit. If problem persists, contact your Amplivox service centre.
WARNING! CALIBRATION EXPIRED Indicator LED c steady light.	The current date is later than the next calibration date.	Check that the clock is set to the correct date. If so, arrange for the instrument to be recalibrated. Tests can still be performed Recalibration needed before further tests are performed.
WARNING! DEVICE UNCALIBRATED. Indicator LED c steady light.	One or more default values require recalibration before further tests are performed.	Contact your Amplivox service centre.
WARNING! DEFAULTS RELOADED. Indicator LED c steady light.	Default configuration settings reloaded.	Default configuration settings reloaded. If the error persists, contact your Amplivox service centre.
Printing Error No connection can be established with the printer	<ul style="list-style-type: none"> Printer is switched off or not charged Cable between printer and cradle not connected. 	<ul style="list-style-type: none"> Remove power from the cradle Restart the printer Charge printer Connect the cable

If difficulties resolving fault conditions occur the equipment distributor (or Amplivox if purchased directly) should be consulted.

15. TECHNICAL SPECIFICATION

15.1. PERFORMANCE

Tympanometry	
Instrument type	Meatus compensated tympanometer
Analysis performed	Compliance peak level (in ml) & pressure; Gradient (in daPa); Ear Canal Volume (ECV) @ 200 daPa
Probe tone levels and accuracy	226Hz +/- 2%; 85dB SPL +/-2dB over range 0.2ml to 5ml
Pressure levels and accuracy	+200daPa to -400daPa +/-10daPa or +/-10% (whichever is larger) over range
Ear volume measurement range and accuracy	0.2ml to 5ml +/- 0.1ml or +/-5% (whichever is larger) over entire range
Sweep speed	Typically 200-300daPa/sec; dependent on ear/cavity volume
Pressure limits (safety cutout)	+600 to -800 daPa
Number of samples stored	100 per tympanogram
Reflex measurements	
Measurement mode	Ipsilateral
Reflex tone levels and accuracy	500Hz,1kHz,2kHz,4kHz (+/-2%) Configurable over range 70dB to100dBHL (4kHz restricted to 95dBHL) +/-3dB, referenced to 2cc calibration volume; Compensates for measured ear volume
Number of reflex levels	Four: 100dB with 5dB or 10 dB steps; 95dB, 90dB or 85dB with 5 dB steps
Reflex analysis	Reflex pass/fail at each level tested; maximum amplitude of each reflex; nominal pressure used for the reflex test (computer display only)
Pressure used for reflex measurement	Pressure at tympanogram peak, or at 0daPa (if no peak found)
Reflex stimulus control	Stimulus presented at all levels, or stimulus ceases when a reflex is found
Reflex detection threshold and accuracy	0.01ml to 0.5ml +/-0.01ml (configurable in 0.01ml steps)
Reflex tone duration	0.6 seconds
Data Management	
Number of records stored in Patient Database	32

Data storage	Any recording can be stored once the tympanogram is viewed. Patient Initials (A-Z, 0-9, "-") must be entered before storage.
Data held	Patient Initials, Tympanogram and Reflex graphs and analysis for Left Ear and/or Right Ear, Time and Date of recording, which ears were tested, whether or not the record has been printed and/or sent to a computer, parameters used for analysis, 128 bit Globally Unique Identifier (GUID)
Display mode	Records listed in reverse chronological order (latest first), with indication of data stored as described above
Real Time Clock	
Time stamps	Time and date stamp applied to all recordings, and to the last calibration date
Backup power supply	> 30 days without the battery being recharged on its cradle
Languages	
Operating Languages	English, German, French, Spanish, Portuguese or Italian. Polish and Russian are also available on request.
Printing	
Supported printer	Sanibel MPT-II
Interface	Wired connection to cradle
Information printed	Tympanogram, Tympanogram analysis parameters, Reflex graphs, Reflex analysis parameters, Serial Number of device, Last and Next Due Calibration dates; space for patient & clinician's details to be entered.
Interface to computer	
Interface	USB version 1.1
Information sent	Patient header, left and right ear test data.
Power Supply	
Battery Types	NiMH rechargeable battery pack (built-in)
Mains power (to cradle)	100-240Vac; 50/60Hz; 0.2A
Warm-up period	None at room temperature
Number of recordings without recharge	Up to 100
Auto power-off delay	90 or 180 seconds
Idle current	70mA
Current while testing	230mA

Physical	
Display	128 x 64 pixels / 8 lines of 21 characters
Dimensions	230mm (L) x 115mm (W) x 70mm (H)
Total Weight (handset and cradle)	650g
Environmental	
Operating temperature range	+15°C to +35°C
Operating humidity range	30% to 90% RH, non-condensing
Operating atmospheric pressure range	980 to 1040 mb
Transport and storage temperature range	-20°C to +70°C
Transport and storage humidity range	10% to 90% RH, non-condensing
Transport and storage atmospheric pressure range	900 to 1100 mb
Standards conformance	
Safety	IEC 60601-1(plus UL, CSA & EN deviations)
EMC	IEC 60601-1-2
Performance	IEC 60645-5, Type 2 Tympanometer ANSI 3.39, Type 2
CE mark	To the EU Medical Device Regulation

15.2. EQUIPMENT CLASSIFICATION

Type of protection against electric shock	Internally Powered
Degree of protection against electric shock	Type BF applied part
Degree of protection against ingress of water	Not protected
Mode of operation	Continuous operation
Equipment mobility	Portable

The Otowave 102-C Tympanometer is classified as a Class IIa device under Annex IX of the EU Medical Devices Regulation.

15.3. SYMBOLS



Definition: Identifies the control by means of which the instrument is switched on from (or returned to) a standby condition.



Definition: Refer to instruction manual (mandatory)



Definition: Type BF applied part – an applied part providing a higher degree of protection against electric shock than that provided by a Type B applied part, particularly regarding allowable patient leakage current and patient auxiliary current.

The applied part is the ear tip.



Definition: Date of Manufacture



Definition: Manufacturer



Definition: Medical product

16. DISPOSAL INFORMATION



Amplivox Limited is fully compliant with the WEEE (Waste Electrical and Electronic Equipment) Regulations. Our PRN (Producer Registration Number) is WEE/GA0116XU and we are registered with the approved WEEE Compliance Scheme, B2B Compliance, approval number WEE/MP3338PT/SCH.

The main purpose of the WEEE Regulations is to encourage the segregation of waste electrical items from the general waste stream and into reuse, recovery and recycling routes.

Therefore, for any waste electrical units purchased from Amplivox that either:

- bear the crossed out wheeled bin symbol with black bar underneath, or
- have been replaced with new Amplivox products on a like-for-like basis

please contact our WEEE Compliance Scheme, B2B Compliance, using the details below. B2B Compliance will be able to provide further information on how to recycle your waste electrical units and answer any queries you may have.

B2B Compliance

Tel: +44 (0) 1691 676 124 (Option 2)

Email: operations@b2bcompliance.org.uk

17. EMC GUIDANCE & MANUFACTURER'S DECLARATION

Guidance and manufacturer's declaration – electromagnetic emissions		
The Otowave 102-C Tympanometer is intended for use in the electromagnetic environment specified below. The customer or user of the Otowave 102-C tympanometer should assure that it is used in such an environment.		
Emissions test	Compliance	Electromagnetic environment – guidance
RF emissions CISPR 11	Group 1	The Otowave 102-C tympanometer uses RF energy only for its internal function. Therefore, its RF emissions are very low and are not likely to cause interference in nearby electronic equipment. The Otowave 102-C tympanometer is suitable for use in all establishments, including domestic establishments and those directly connected to the public low-voltage power supply network that supplies buildings used for domestic purposes.
RF emissions CISPR 11	Class B	
Harmonic emissions IEC 61000-3-2	Not applicable	
Voltage fluctuations/flicker emissions IEC 61000-3-3	Not applicable	

Guidance and manufacturer's declaration – electromagnetic immunity (1)			
The Otowave 102-C tympanometer is intended for use in the electromagnetic environment specified below. The customer or user of the Otowave 102-C tympanometer should assure that it is used in such an environment.			
Immunity test	IEC 60601 test level	Compliance level	Electromagnetic environment – guidance
Electrostatic Discharge (ESD) IEC 61000-4-2	±6 kV contact ±8 kV air	±6 kV contact ±8 kV air	Floors should be wood, concrete or ceramic tile. If floors are covered with synthetic material, the relative humidity should be at least 30%
Electrical fast transient/burst IEC 61000-4-4	±2 kV for power supply lines ±1 kV for input/output lines	Not applicable	
Surge IEC 61000-4-5	±1 kV differential mode ±2 kV common mode	Not applicable	Not applicable

Immunity test	IEC 60601 test level	Compliance level	Electromagnetic environment – guidance
Voltage dips, short interruptions and voltage variations on power supply input lines IEC 61000-4-11	<5% U_T (>95% dip in U_T) for 0.5 cycle 40% U_T (60% dip in U_T) for 5 cycles 70% U_T (30% dip in U_T) for 25 cycles <5% U_T (>95% dip in U_T) for 5 sec	Not applicable	Not applicable
Power frequency (50/60 Hz) magnetic field IEC 61000-4-8	3 A/m	3 A/m	Power frequency magnetic fields should be at levels characteristic of a typical location in a typical commercial or hospital environment.
NOTE U_T is the a.c. mains voltage prior to the application of the test level			

Guidance and manufacturer's declaration – electromagnetic immunity (2)			
The Otowave 102-C tympanometer is intended for use in the electromagnetic environment specified below. The customer or user of the Otowave 102-C tympanometer should assure that it is used in such an environment.			
Immunity test	IEC 60601 test level	Compliance level	Electromagnetic environment – guidance
Radiated RF IEC 61000-4-3	3 V/m 80MHz to 2.5GHz	3 V/m	<p>Portable and mobile RF communications equipment should be used no closer to any part of the Otowave 102-C tympanometer, including cables, than the recommended separation distance calculated from the equation applicable to the frequency of the transmitter.</p> <p>Recommended separation distance</p> <p>$d = 1.2\sqrt{P}$ 80MHz to 800MHz</p> <p>$d = 2.3\sqrt{P}$ 800MHz to 2.5GHz</p> <p>where P is the maximum output power rating of the transmitter in Watts (W) according to the transmitter manufacturer and d is the recommended separation distance in metres (m).</p> <p>Field strengths from fixed RF transmitters, as determined by an electromagnetic site survey,^a should be less than the compliance level in each frequency range.^b</p> <p>Interference may occur in the vicinity of equipment marked with the following symbol:</p> <div style="text-align: center;">  </div>
NOTE 1 At 80MHz and 800MHz, the higher frequency range applies.			
NOTE 2 These guidelines may not apply in all situations. Electromagnetic propagation is affected by absorption and reflection from structures, objects and people.			

Guidance and manufacturer's declaration – electromagnetic immunity (2)	
a	Field strengths from fixed transmitters, such as base stations for radio (cellular/cordless) telephones and land mobile radios, amateur radio, AM and FM radio broadcast and TV broadcast cannot be predicted theoretically with accuracy. To assess the electromagnetic environment due to fixed RF transmitters, an electromagnetic site survey should be considered. If the measured field strength in the location in which the Otowave 102-C tympanometer is used exceeds the applicable RF compliance level above, the Otowave 102-C tympanometer should be observed to verify normal operation. If abnormal performance is observed, additional measures may be necessary, such as re-orienting or relocating the Otowave 102-C tympanometer.
b	Over the frequency range 150 kHz to 80 MHz, field strengths should be less than 3 V/m.

Recommended separation distances between portable and mobile RF communications equipment and the Otowave 102-C tympanometer			
The Otowave 102-C tympanometer is intended for use in an electromagnetic environment in which radiated RF disturbances are controlled. The customer or the user of the Otowave 102-C tympanometer can help prevent electromagnetic interference by maintaining a minimum distance between portable and mobile RF communications equipment (transmitters) and the Otowave 102-C tympanometer as recommended below, according to the maximum output power of the communications equipment.			
Rated maximum output power of transmitter W	Separation distance according to frequency of transmitter m		
	150 kHz to 80 MHz	80 MHz to 800 MHz	800 MHz to 2.5 GHz
	d = 1.2√P	d = 1.2√P	d = 2.3√P
0.01	0.12	0.12	0.23
0.1	0.38	0.38	0.73
1	1.2	1.2	2.3
10	3.8	3.8	7.3
100	12	12	23
For transmitters rated at a maximum output power not listed above, the recommended separation distance d in metres (m) can be estimated using the equation applicable to the frequency of the transmitter, where P is the maximum output power rating of the transmitter in Watts (W) according to the transmitter manufacturer.			
NOTE 1 At 80MHz and 800MHz, the separation distance for the higher frequency range applies.			
NOTE 2 These guidelines may not apply in all situations. Electromagnetic propagation is affected by absorption and reflection from structures, objects and people.			

18. USE WITH NON-MEDICAL ELECTRICAL EQUIPMENT

Any person who connects external equipment to signal input, signal output or other connectors has created a medical electrical system and is therefore responsible for the system complying with the requirements of clause 16 of IEC 60601-1:2005 (*General requirements for basic safety and essential performance*).

If connections are made to standard equipment such as printers and computers, special precautions must be taken in order to maintain medical safety. The following notes are provided for guidance in making such connections to ensure that the general requirements of clause 16 of IEC 60601-1:2005 are met.

External equipment intended for connection to signal input, signal output or other connectors, shall comply with the relevant IEC or international standards (e.g. IEC 60950, CISPR 22 & CISPR 24 for IT equipment, and the IEC 60601 series for medical electrical equipment).

Equipment not complying with IEC 60601 shall be kept outside the patient environment, as defined in IEC 60601-1:2005 (at least 1.5m from the patient).

The operator must not touch the connected equipment and the patient at the same time as this would result in an unacceptable hazard.

Refer to Diagrams 1 & 2 below for typical configurations of connected peripheral equipment.

Refer to Amplivox Limited at the address given on the front of this user manual if advice is required regarding the use of peripheral equipment.

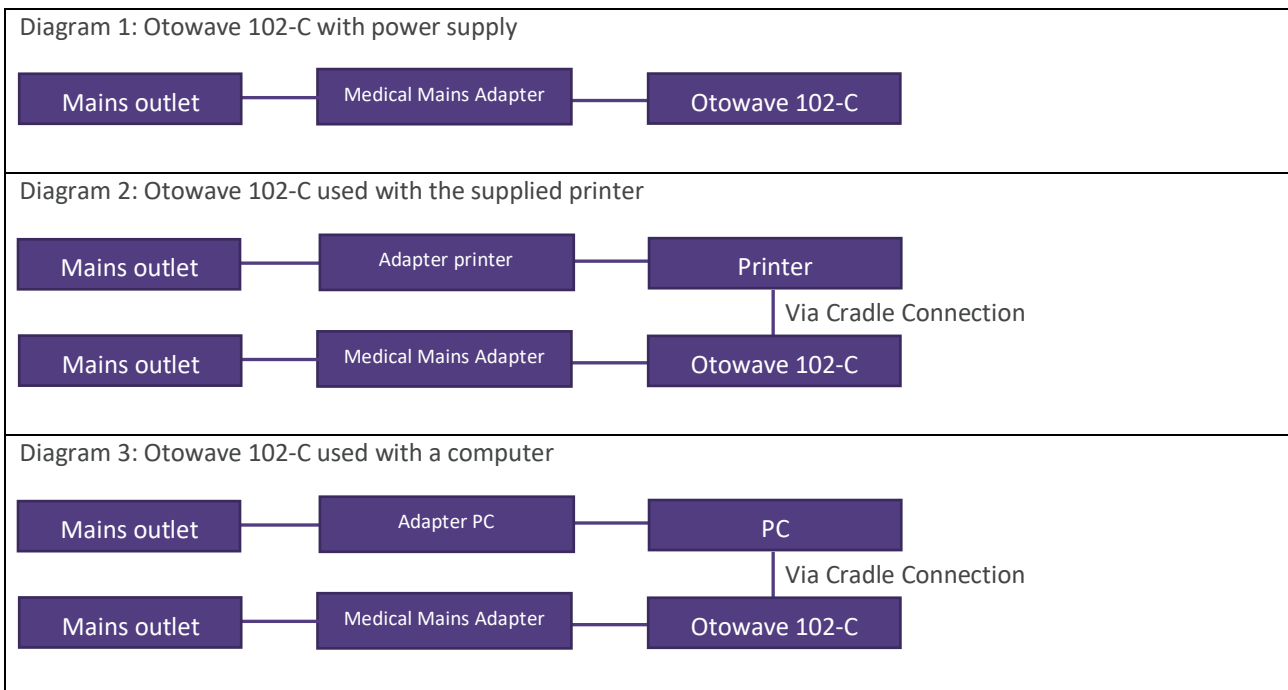



Copyright © 2022 Amplivox Ltd
All rights reserved. No part of this publication may be reproduced or transmitted in any form or by any means without the prior written permission of Amplivox Ltd.